

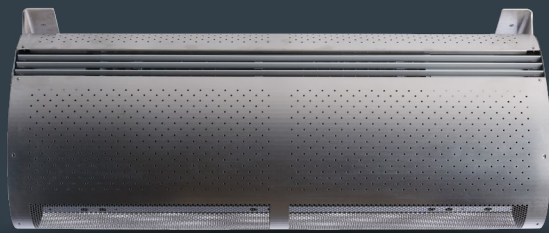

PHV Series Designer.

Combining contemporary design with outstanding performance.

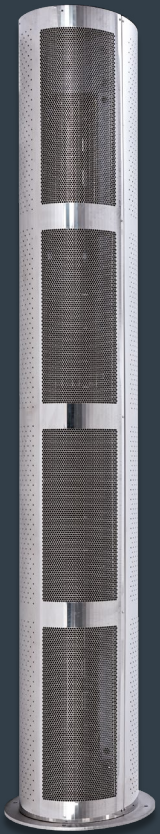

Stylish, yet very powerful, **Thermoscreens PHV Designer** air curtains are a smart choice for applications where appearances matter. Available in a range of bespoke finishes with a choice of mounting options, they fit in anywhere – and go with anything.

Sizes

Horizontal: 1m, 1.5m and 2m
Vertical: 1.5m, 2m, 2.5m (Stacked) and 3m (Stacked)

Mounting Height

Surface mounted - up to 3.5m

Colour

Standard high polished or satin brushed stainless steel
RAL colours matching available

Warranty

2 years

Key features.



Water



Electric



Ambient



ErP compliant



Custom Paint

- Stylish, contemporary design
- Ambient, water heated or electric heated
- Surface mounted
- Ecopower energy saving controls (water heated and electric heated units)
- ErP compliant and BMS ready
- Heating coils for low or high-grade water temperatures (60°C to 90°C)
- Operate up to eight units with one control
- Water heated units supplied with motorised three-port valve factory fitted inside unit
- 82/71 coils (water heated units)
- Choice of mounting options: horizontal or vertical
- Downrated single phase output (electric units)
- Choice of wall, ceiling, and goalpost brackets





PHV Series Designer | Horizontal

Model	Dimensions (L x W x D) (mm)	Supply (50Hz)	Loading (A) per phase	Heat output (kW)	Max velocity (m/s)	Max air volume (m ³ /h)	Weight (kg)	Noise output dB(A) @3m		
								H	M	L
Electric										
PHVD1000E	1260x500x350	400V~3P&N	18.7	6/12	10.5	1870	57	59	57	56
PHVD1500E	1722x500x350	400V~3P&N	27.9	9/18	10.5	3325	71	60	57	53
PHVD2000E	2355x500x350	400V~3P&N	37.5	12/24	10.5	3780	99	61	59	58
Water 2 row 82/71										
PHVD1000W	1260x500x350	230V~1P&N	1.3	6/12	9.5	1710	61	59	57	56
PHVD1500W	1722x500x350	230V~1P&N	1.8	9/18	9.5	3040	82	60	57	53
PHVD2000W	2355x377x255	230V~1P&N	2.7	12/24	9.5	3455	107	61	59	58
Water 3 row 60/40										
PHVD1000W	1260x500x350	230V~1P&N	1.3	6/12	9.0	1540	61	59	57	56
PHVD1500W	1722x500x350	230V~1P&N	1.8	9/18	9.0	2740	82	60	57	53
PHVD2000W	2355x500x350	230V~1P&N	2.7	12/24	9.0	3110	107	61	59	58
Ambient										
PHVD1000A	1260x500x350	230V~1P&N	1.5	-	11.0	2050	54	59	57	56
PHVD1500A	1722x500x350	230V~1P&N	1.8	-	11.0	3645	67	60	57	53
PHVD2000A	2355x500x350	230V~1P&N	2.9	-	11.0	4145	93	61	59	58

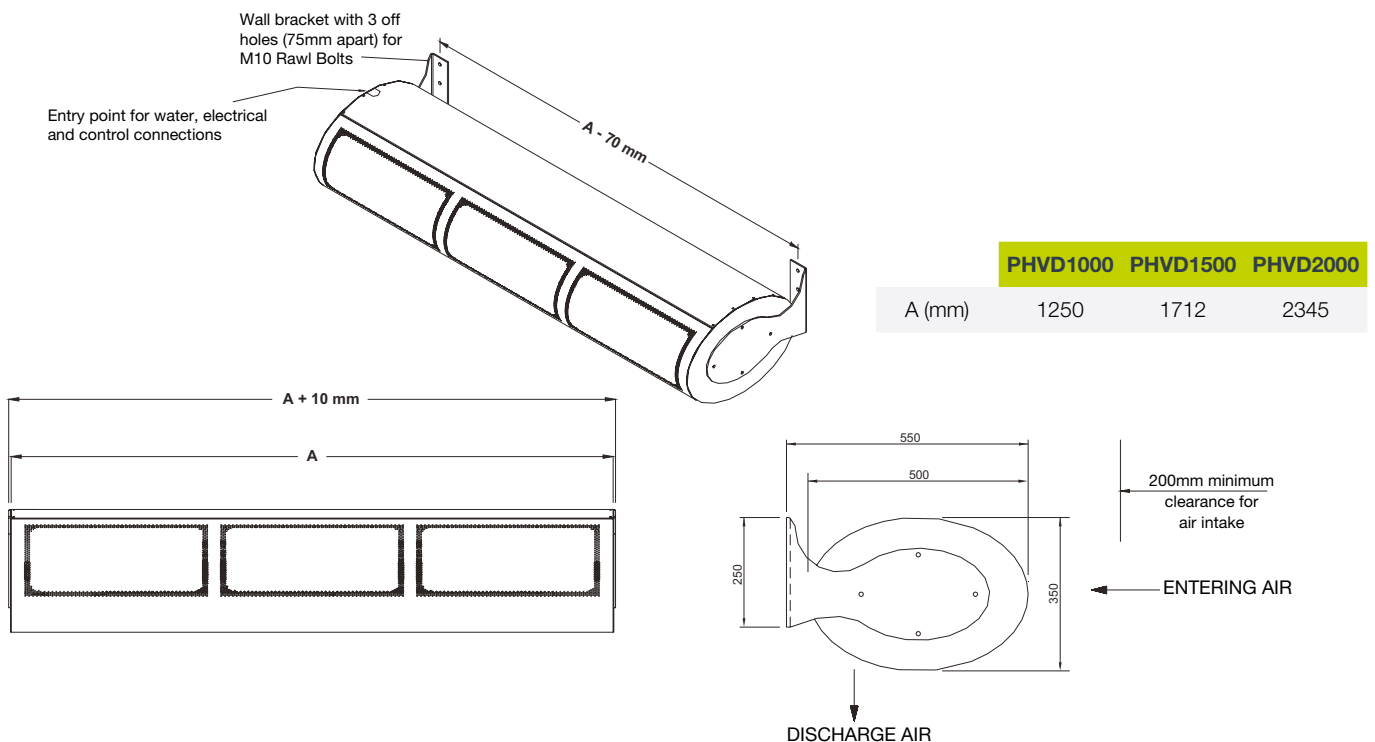



PHV Series Designer | Vertical

Model	Dimensions (L x W x D) (mm)	Supply (50Hz)	Loading (A) per phase	Heat output (kW)	Max velocity (m/s)	Max air volume (m ³ /h)	Weight (kg)	Noise output dB(A) @3m		
								H	M	L
Electric										
PHVD1000E V	1260x500x350	400V~3P&N	18.7	6/12	10.5	1870	57	59	57	56
PHVD1500E V	1722x500x350	400V~3P&N	27.9	9/18	10.5	3325	71	60	57	53
PHVD2000E V	2355x500x350	400V~3P&N	37.5	12/24	10.5	3780	99	61	59	58
PHVD2500E V Stacked Unit	2972x500x350	400V~3P&N	18.7 top 27.9 bottom	6/12 9/18	10.5	1870 3325	128	62	60	59
PHVD3000E V Stacked Unit	3619x500x350	400V~3P&N	18.7 top 37.5 bottom	6/12 12/24	10.5	1870 3780	156	63	61	60
Water 82/71										
PHVD1000W V	1260x500x350	230V~1P&N	1.3	6/12	9.5	1710	61	59	57	56
PHVD1500W V	1722x500x350	230V~1P&N	1.8	9/18	9.5	3040	82	60	57	53
PHVD2000W V	2355x500x350	230V~1P&N	2.7	12/24	9.5	3455	107	61	59	58
PHVD2500W V Stacked Unit	2972x500x350	230V~1P&N	1.3 top 1.8 bottom	6/12 9/18	9.5	1710 3040	143	62	60	59
PHVD3000W V Stacked Unit	3619x500x350	230V~1P&N	1.3 top 2.7 bottom	6/12 12/24	9.5	1710 3455	168	63	61	60
Ambient										
PHVD1000A V	1260x500x350	230V~1P&N	1.5	-	11.0	2050	54	59	57	56
PHVD1500A V	1722x500x350	230V~1P&N	1.8	-	11.0	3645	67	60	57	53
PHVD2000A V	2355x500x350	230V~1P&N	2.9	-	11.0	4145	93	61	59	58
PHVD2500A V Stacked Unit	2972x500x350	230V~1P&N	1.5 top 1.8 bottom	-	11.0	2050 3645	121	62	60	59
PHVD3000A V Stacked Unit	3619x500x350	230V~1P&N	1.5 top 2.9 bottom	-	11.0	2050 4145	147	63	61	60

PHVD2500 and PHVD3000V units consist of 2 air curtains joined together as a stack on site. Each separate air curtain needs its own electrical power supply to the electrical terminal block inside the unit. Control cables can be wired master / slave inside the units with one remote control to operate both units.

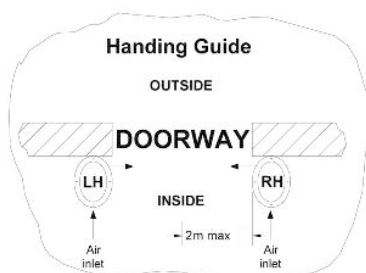
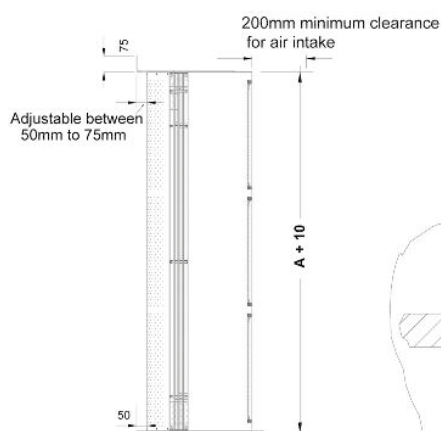

As Drawn for R.H.
 Opposite Hand for L.H.

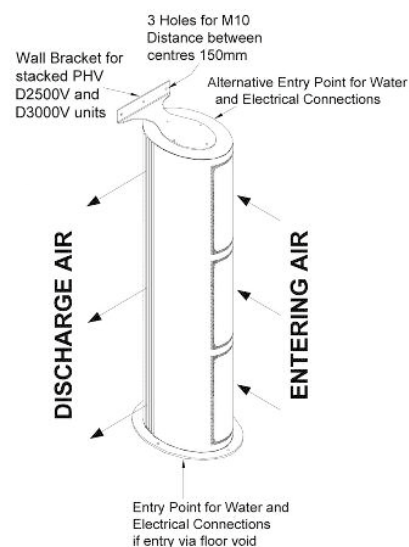
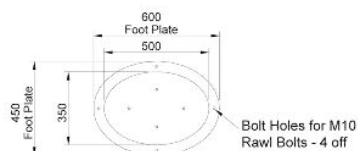

PHVD1500V PHVD2000V PHVD2500V PHVD3000V

A (mm) 1712 2345 2962 3609

Water flow rate and pressure drop calculations for different water temperatures.

To calculate water flow rate and coil pressure drop, use our coil calculation programme. Then calculate the new water drop (valve) using the following formula:

$$\text{New Water Pressure Drop (valve)} = \text{82/71 Water Pressure Drop (valve)} \times \left(\frac{\text{New Water Flow Rate}}{\text{82/71 Water Flow Rate}} \right)^2$$

Example:

PHVD1000WV at 85/65°C, EAT = 20°C
82/71 Water flow rate = 15.6 l/min
(from water flow rate and pressure drop table below)

New water flow rate = 8.0 l/min
(from Thermoscreens coil calculation programme)

New water pressure drop (coil) = 0.3 kPa
(from Thermoscreens coil calculation programme)

Therefore:

New water pressure drop (valve) =

$$5.5 \times \left(\frac{8}{15.6} \right)^2 = 1.5 \text{ kPa}$$

Conversion factors:

1 kPa = 0.102m Water column
10 l per minute = 0.6 m³/h

Water flow rate and pressure drop.

PHV Series Designer Horizontal	2 row coil (based on 82/71°C)			3 row coil (based on 60/40°C)		
	Water flow rate (l/min)	Water pressure drop (coil) ΔP (kPa)	Water pressure drop (valve) ΔP (kPa)	Water flow rate (l/min)	Water pressure drop (coil) ΔP (kPa)	Water pressure drop (valve) ΔP (kPa)
PHVD1000W	15.6	0.9	5.5	8.6	7.3	2.5
PHVD1500W	23.4	2.3	7.0	12.9	6.5	3.5
PHVD2000W	31.2	4.9	10.0	17.1	13.9	4.5

PHV Series Designer Vertical	2 row coil (based on 82/71°C)		
	Water flow rate (l/min)	Water pressure drop (coil) ΔP (kPa)	Water pressure drop (valve) ΔP (kPa)
PHVD1000WV	15.6	0.9	5.5
PHVD1500WV	23.4	2.3	7.0
PHVD2000WV	31.2	4.9	10.0

Accessories.

Description	Part no.
Master and salve lead: 3M + coupler	T5951110
6M Extension cable + coupler	T5951111
10M Extension cable + coupler	T5951112
15M Extension cable + coupler	T5951113
30M Extension cable + coupler	T5951114
Extension lead coupler	T5951030
Joining kit (1m, 1.5 and 2m)	T7308185

A 3-port motorised control valve is factory fitted inside each water heated Designer PHV air curtain. PHVD2500 and PHVD3000V units consist of 2 air curtains joined together as a stack on site. Each separate air curtain needs its own electrical power supply to the electrical terminal block inside the unit. Control cables can be wired master / salve inside the units with one remote control to operate both units. Each separate air curtain needs its own Flow / Return pipework to be installed on site. Use the data from the table on the next page for each unit in the stack.

PHVD2500V = PHVD1500V + PHVD1000V

PHVD3000 = PHVD2000+PHVD1000

